

Data Sheet

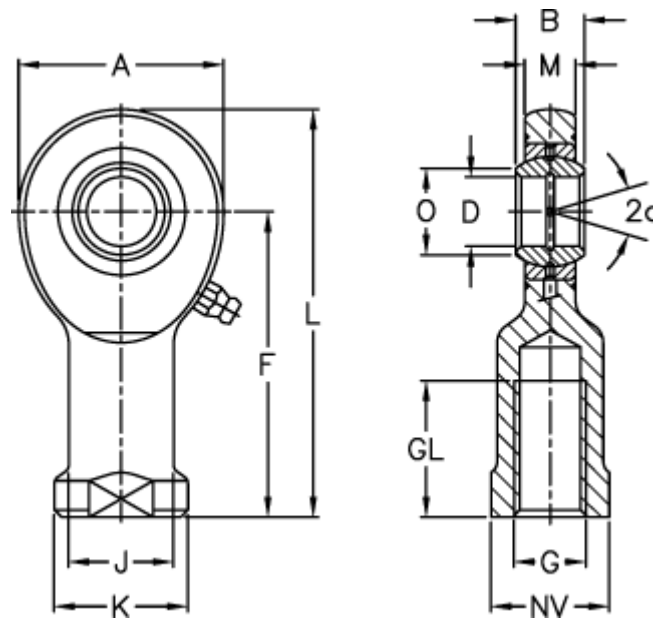

Article number: 03481080
 Description: Fluro Rod end EIL 80-2RS
 Note: 80

Measures



A	= 180	J	= 95
a (degrees)	= 6	K	= 110
B	= 55	L	= 320
D	= 80	M	= 47
Dynamic drive (kN)	= 400	NV	= 100
F	= 230	O	= 89.4
g	= M64x4	Static drive kN	= 752
GL	= 85	Weight	= 12000